

Climatización

Hispacold
Carrier Sütrak
Thermoking
Airbus
Spal
Eberspächer
Webasto
Aurora
Turbinas
Ventiladores
Despieces
Extractores y respiraderos

AUDAX®
Suministros de Automoción

CLIMATIZACIÓN

CLIMATIZACIÓN · HERRAMIENTAS DE CARGA

<p>Bomba vacío 134A doble. Ref. 3050001</p> 	<p>Conjunto manómetros. Ref. STB22SS Manómetro baja. Ref. ML6018R1A6 Manómetro alta. Ref. ML6038R1A6</p> 	<p>Conjunto mangueras. Ref. ST303FT1500</p> 
<p>Kit manómetros y mangueras. Ref. 850803</p> 	<p>Conexión baja. Ref. 3400007</p> 	<p>Conexión alta. Ref. 3400006</p> 
<p>Unión 1/4 a 1/4. Ref. 3400603</p> 	<p>Reducción. 3/8 macho x 3/8 macho Ref. 3400126 1/2 hembra x 3/8 macho cónica Ref. 3400122</p> 	<p>Conexión mangueras "T" 1/4. Ref. 110190</p> 
<p>Reducción. 1/2 macho x 3/8 hembra. Ref. 3400123 3/8 hembra x 1/4 macho. Ref. 3400128</p> 	<p>Llave carraca. Ref. 3550057</p> 	<p>Racor botella. Ref. 4300436</p> 
<p>Enchufe rápido baja hembra. Ref. 4300303</p> 	<p>Enchufe rápido alta hembra. Ref. 4300305</p> 	<p>Aditivo detector. Ref. 3550145</p> 
<p>Peine para aletas. Ref. 3550065</p> 	<p>Detector fugas. Ref. 3550112</p> 	<p>Detector fugas. Ref. 19B0095</p> 

CLIMATIZACIÓN

CLIMATIZACIÓN · COMPONENTES DE INSTALACIÓN

Filtro deshidratador pequeño rosca.
Modelo 163. Ref. DCL163R
Modelo 164. Ref. DCL164R



Filtro deshidratador grande rosca.
Modelo 303. Ref. DCL303R
Modelo 304. Ref. DCL304R
Modelo 305. Ref. DCL305R



Orificio nº: 2. Ref. 3100031
Orificio nº: 3. Ref. 3100032
Orificio nº: 4. Ref. 3100033
Orificio nº: 5. Ref. 3100035
Orificio nº: 6. Ref. 3100036



Filtro T2.
Ref. 3270014



Cuerpo válvula expansión Ten 2.
Ref. 3100009
Válvula expansión.
TDN 3,1. Ref. 3100082
Toex 4,5 (E0456). Ref. 3100096
Toex 4,5 (E0455). Ref. 3100099
Toex 3,0. Ref. 3100133



Compensador presión.
0,6 mm. Ref. 3100100
300. Ref. 4220112
0,3 mm. Ref. 310097



Válvula Rotaloc.
1/2. Ref. 3100064
5/8. Ref. 3100065



Aceite 4 lts. Suniso SI68.
Ref. 132G



Visor depósito.
Macho - macho 1/2. Ref. 3100079
SG-12. Macho - hembra 3/4. Ref. 3100081



CLIMATIZACIÓN

CLIMATIZACIÓN · HERRAMIENTAS Y COMPRESORES

Útil montaje rodamientos, poleas y embragues.
Ref. 4400050



Extractor embrague.
Ref. 4400023



Extractor embrague DK-26.
Ref. 4400024



Llave embrague.
Ref. 4400027



Llave visor.
Ref. 4400028



Útil montaje conjunto fricción.
Ref. 4400049



Extractor embrague 660 C.C.
Ref. 4400060



Útil montaje retén Ecoice.
Ref. 4400064



Extractor ventilador.
Ref. 4400057



Kit cambio rodamientos Ecoice.
Ref. 4400087



Válvula alta Racor 1" - 1/16.
Ref. 4200072

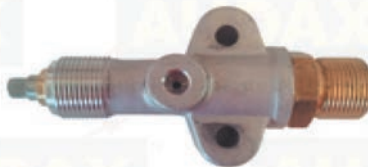

Válvula baja.
Ref. 4200080



Compresores:
Bitzer. 600 cc. Ref. 4NFCY
Bock
560 cc. Ref. FKX40560
655 cc. Ref. FKX40655
Carrier. Ref. CCARRIER
Hispacold
600 cc. Ref. 7010057
660 cc. Ref. 7010070
Thermoking. Ref. X430N





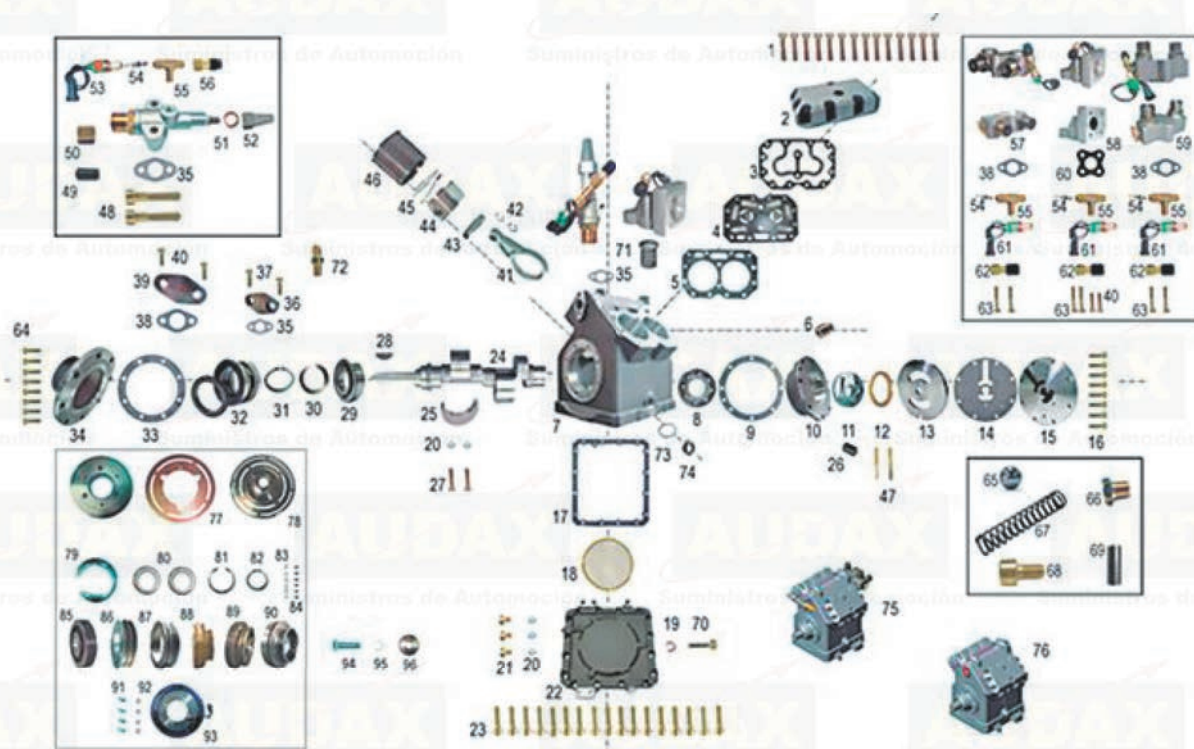

















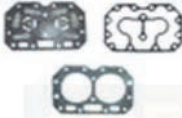

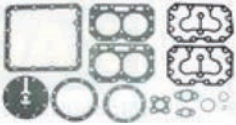
CLIMATIZACIÓN · DESPIECE COMPRESOR ECOICE



Nº Ref.	Descripción	Cant.	Nº Ref.	Descripción	Cant.	Nº Ref.	Descripción	Cant.			
1	3400203	Tornillo 10-150x40 8.8 912	28	34	4200298	Tapa lado embrague	1	66	3300312	Tapón 1/8-M GAS especial	1
2	4200297	Tapa cilindro compresor.	2	35	3600101	Junta válvula de alta	2	67	3300407	Muelle interior válvula	1
3	3600126	Junta culata.	2	36	4200339	Tapa válvula de alta	1	68	3400190	Tornillo 10-150x16 8.8 912	1
4	3550213	Plato válvula compresor.	2	37	3400455	Tornillo 8-125x20 8.8 912	2	69	3300415	Pasador 5x12 7 A	1
5	3600125	Junta plato válvula.	2	38	3600102	Junta válvula de baja	2	70	3400196	Tornillo 10-150x20 8.8 933	1
6	3220070	Válvula de seguridad.	1	39	4200333	Tapa válvula de baja	1	71	3220074	Filtro entrada compresor	1
7	4200296	Cárter compresor.	1	40	3400929	Tornillo 10-150x25 8.8 912	2	72	4300360	Acoplamiento 1/8MG-1/4MS	1
8	3450023	Rodamiento 6309.	1	41	4200302	Biela compresor	4	73	3600133	Junta tórica 28x1.5 NBR	2
9	3600127	Roda cuerpo bomba.	1	42	3300046	Anilla I-18 DIN 472	8	74	3100110	Visor de aceite	2
10	4200300	Cuerpo bomba compresor.	1	43	3220066	Bulón compresor	8	75	5050146	Compresor 660c.c. con válvulas	-
11	4200226	Cto. rotor-bomba.	1	44	3050075	Pistón 72.5mm	4	76	5050156	Compresor 660c.c. sin válvulas	-
12	4200228	Anillo inversión E=8mm.	1	45	3220067	Segmento 72.5x1.8 torsional	4	77	4200321	Plato fricción	1
13	4200097	Disco fricción exterior.	1	46	3220068	Seg. 72.5x1.8 torsional+rasc.	4	78	4050078	Cuerpo embrague	1
14	3600128	Junta tapa bomba.	1	47	4200312	Camisa compresor	4	79	3550216	Fleje embrague compresor	1
15	4200301	Tapa bomba compresor.	1	48	4200109	Fleje inversión	2	80	3450034	Rodamientos 6010 2Z	2
16	3400465	Tornillo 8-125x40 8.8 912.	8	49	3400471	Tornillo 8-125x50 8.8 912	2	81	3300058	Anilla I-80 DIN 472	1
17	3600130	Junta tapa carter.	1	49	3350191	Tapón de plástico	1	82	3300404	Anilla E-50 DIN 471	1
18	4200108	Filtro tapa cárter	1	50	3300310	Tapón ¼-H SAE	1	83	3300074	Arandela A.E.T. 8,4	6
19	3300083	Arandela de cobre 10x16x1.5	1	51	3300085	Arandela cobre 20x24.5x1.5	1	84	3400857	Tornillo 8-125x10 8.8 912	6
20	3300073	Arandela A.E.T. 6,4	5	52	3220009	Capuchón válvula de alta	1	85	4050079	Embrague 4V660 2B ø210	-
21	3400758	Tornillo 6-100x8 8.8 912	3	53	4150179	Presostato de alta	1	86	4050085	Emb. 4V660 2B ø250	-
22	4200299	Tapa inferior compresor	1	54	3100029	Obus 3521 1-80	1	87	4050083	Emb. 4V660 9PK ø205+1A ø214	-
23	3400198	Tornillo 10-150x30 8.8 912	16	55	3400144	Té 1/4MSx1/8MGx1/4MS	1	88	4050087	Emb. 4V660 2Bø175+1Aø250	-
24	4200315	Cigüeñal	1	56	4300305	Enchufe rápido alta hembra	1	89	4050081	Emb. 4V660 2B ø210+2A ø260	-
25	3300402	Contrapeso cigüeñal	1	57	4301082	Colector de baja horizontal	1	90	4050084	Emb. 4V660 9PK ø150+1A ø214	-
26	3300398	Chaveta 4x4x7.5 6885-B	1	58	4200379	Colector de baja	1	91	3400450	Tornillo 8-125x12 5.6 933	4
27	3400417	Tornillo 6-100x30 8.8 912	2	59	4301083	Colector de baja vertical	1	92	3300105	Arandela dentada 8 6769-J	4
28	3300399	Chaveta disc. 5x9x22 DIN 6888	1	60	3600142	Junta colector de baja	1	93	4150340	Bobina embrague	1
29	3450035	Rodamientos NUP 309	1	61	4150181	Presostato de baja	1	94	3400271	Tornillo M12-175X40 8.8 933	1
30	3300187	Arandela cierre	1	62	4300303	Enchufe rápido de baja	1	95	3300114	Arandela Grower ø12	1
31	3300400	Anilla E-45 DIN 471	1	63	3400215	Tornillo 10-150x70 8.8 912	2	96	4180548	Arandela Especial	1
32	3220069	Cto. reten 40mm.	1	64	3400458	Tornillo 8-125x25 8.8 912	8				
33	3600129	Junta tapa embrague	1	65	3220002	Bola 17/64"	1				

CLIMATIZACIÓN · DESPIECES COMPRESORES

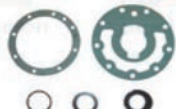
<p>Kit tóricas 4v 600 cc. Ref. 3600004</p> 	<p>Kit pistón-biela camisa 4v 600 cc. Ref. 4200055</p> 	<p>Válvula descarga 4v 500 cc. Ref. 4200196</p> 
<p>Válvula descarga 4v 600 cc. Ref. 4200197</p> 	<p>Kit válvula 4v 660 cc. Ref. 4200488</p> 	<p>Kit segmentos 4v 600 cc. Ref. 4200390</p> 
<p>Kit filtro aspiración + junta 4v 500/600 cc. Ref. 4200490</p> 	<p>Kit reparación válvula 4v 600 cc. Ref. 4200494</p> 	<p>Kit reparación válvula 4v 500 cc. Ref. 4200495</p> 
<p>Compresor 4v 600 cc. sin válvulas. Ref. 5050029</p> 	<p>Kit retén Ecoice. Ref. 4200376</p> 	<p>Kit camisa-pistón biela Ecoice. Ref. 4200425</p> 
<p>Kit segmentos 4v 600 cc. Ref. 4200426</p> 	<p>Kit segmentos 4v 660 cc. Ref. 4200427</p> 	<p>Kit rodamientos cigüeñal 4v 660 cc. Ref. 4200428</p> 
<p>Kit juntas 4v 600 cc. Ref. 4200429</p> 	<p>Kit juntas válvulas 4v 660 cc. Ref. 4200430</p> 	<p>Kit filtro aspiración 4v 660 cc. Ref. 4200480</p> 
<p>Kit cigüeñal 4v 500/600 cc. Ref. 4200283</p> 	<p>Kit cigüeñal 4v 660 cc. Ref. 4200493</p> 	<p>Kit cigüeñal 6w 600 cc. con rodamientos. Ref. 4200492</p> 
<p>Kit pistón-biela camisa 6w 600 cc. Ref. 4200386</p> 	<p>Kit bomba aceite. Ref. 4200387</p> 	<p>Kit retén. Ref. 4200065</p> 

CLIMATIZACIÓN

CLIMATIZACIÓN · DESPIECES COMPRESORES

Kit reparación Bock.
Ref. 80023



Kit reparación Bitzer.
Ref. 37402306



Compresor SD5H14 12 V. R134A Poly-V7 vertical.
Ref. 3050011



Compresor SD7H15 12 V. R134A Poly-V8 horizontal.
Ref. 3050050



Compresor UX330 24 V. R134A 2 canales.
Ref. 3050044



Compresor SD7H15 12 V. R134A Poly-V8 vertical.
Ref. 3050015



Compresor HC320 2 canales.
Ref. 3050095



Compresor HC180 12 V. R134A PV4.
Ref. 3050102



Compresor HC320 R134A 2 canales.
Ref. 3050108



Compresor HC320 R134A PV8.
Ref. 3050109



Compresor HC320 R134A PV8 S/EMB.
Ref. 3050110



Compresor HC180 R134A PV6.
Ref. 3050118



Compresor TM31 R134A 24 V. 2B.
Ref. 5050002



Compresor SD5H09 R134A 24 V. 2 canales.
Ref. 5050003



Compresor TM31 R134A 24 V. PV8.
Ref. 5050095



Compresor TM31 R134A 2A.
Ref. 5050193



Compresor Unicla UX310 2B 24 V. RP.
Ref. 7010059



CLIMATIZACIÓN · BOBINAS Y POLEAS HISPACOLD

Embragues y bobinas 4v. y 6w.

Referencia	A	B	C	D
4050012	210		2A	
4050039	210		7PK	
4050037	210	260	3B	1A
4050035	210	250	2B	2A
4050034	215	250	2B	2A
4050029	250	250	2B	2A
4050023	210		3B	
4050021	250		2B	
4050019	210		2B	
4050070	210		2B	

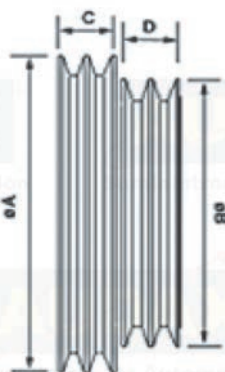

Bobina embrague aluminio.
Ref. 4150022



Embragues y bobinas Ecoice.

Referencia	A	B	C	D
4050293	210		2B	
4050294	210	260	2B	2A
4050295	205	214	9PK	1A
4050296	150	215	9PK	1A
4050297	250		2B	
4050299	175		2B	
4050300	175	260	2B	1A
4050303	175	260	2B	1A

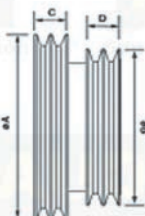

Bobina embrague estanca aluminio.
Ref. 4150019



Poleas intermedias.

Referencia	A	B
4250059	82	66
4250062	75	30
4250448		

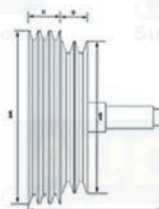

Bobina 24 V. embrague Ecoice estanca
CU.
Ref. 4150340

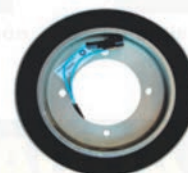

Rodillos tensores.

Referencia	A	B	C	E
4250016	140		2A	60
4250352	130	155	4B	73
4250111	140		2B	68,5
4250110	140		2B	46
4250107	140		2B	68,5
4250105	140		2B	82
4250093	105		2B	48
4250092	105		2B	51
4250043	105		2B	61
4250036	160		4B	100
4250030	140		2B	99
4250022	140		2B	53
4250020	140		2B	
4250019	105		2B	51
4250018	140		2B	46,5
4250017	140		2B	61
4250334	155		4B	85

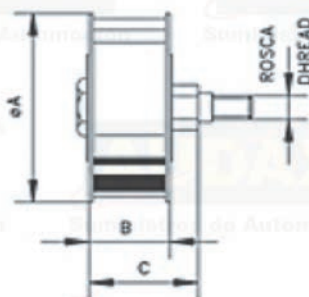

Silentblock Mecahone 11 70 Shores.
Ref. 3350221



Silentblock puente.
Ref. 4180287



Silentblock.
Ref. 4180289



CLIMATIZACIÓN

CLIMATIZACIÓN · RACORES Y MANGUERAS HISPACOLD

<p>Tubería Nylaflow galga 10. Ref. 3500003</p> 	<p>Tubería Nylaflow galga 12. Ref. 3500004</p> 	<p>Tubería Nylaflow galga 6. Ref. 3500006</p> 
<p>Tubería goma 1 1/8 Barrier NETR5R. Ref. 3500003</p> 	<p>Tubería Nilaflex. G12. Ref. 3500094 G16. Ref. 3500095</p> 	<p>Tubería Manuli. DN10,5. Ref. 3500028 DN16. Ref. 3500029 DN22. Ref. 3500030</p> 
<p>Racores reusables O-Ring.</p>		
<p>Recto G-16 T.G. 1" 5/16. Ref. 4300674 G-12 T.G. 1" 1/16. Ref. 4300670</p> 	<p>45° G-16 T.G. 1" 5/16. Ref. 4300676 G-16 T.G. 1" 1/16. Ref. 4301175 G-12 T.G. 1" 1/16. Ref. 4300672</p> 	<p>90° G-16 T.G. 1" 5/16. Ref. 4300675 G-12 T.G. 1" 1/16. Ref. 4300671</p> 
<p>Racores engatillados O-Ring.</p>		
<p>Recto G-12 T.G. 1" 1/16. Ref. 4300293 G-10 T.G. 7/8". Ref. 4300290 G-6 T.G. 5/8". Ref. 4300287</p> 	<p>45° G-12 T.G. 1" 1/16. Ref. 4300291 G-10 T.G. 7/8". Ref. 4300288</p> 	<p>90° G-12 T.G. 1" 1/16. Ref. 4300292 G-10 T.G. 7/8". Ref. 4300289 G-6 T.G. 5/8". Ref. 4300286</p> 
<p>Racores reusables cónicos.</p>		
<p>Recto G-12 T.G. 1" 1/16. Ref. 4300463 G-12 T.G. 7/8". Ref.- 4300466 G-10 T.G. 7/8". Ref.- 4300461 G-10 T.G. 3/4". Ref. 4300459 G-6 T.G. 5/8". Ref. 4300468</p> 	<p>45° G-12 T.G. 7/8". Ref. 4300379 G-12 T.G. 1" 1/16. Ref. 4300377 G-10 T.G. 7/8". Ref. 4300373 G-10 T.G. 3/4". Ref. 4300371 G-10 T.G. 1" 1/16. Ref. 4300370 G-6 T.G. 5/8 ". Ref. 4300381</p> 	<p>90° G-12 T.G. 1" 1/16. Ref. 4300423 G-12 T.G. 7/8". Ref. 4300425 G-10 T.G. 3/4". Ref. 4300418 G-10 T.G. 7/8". Ref. 4300420 G-6 T.G. 5/8". Ref. 4300429</p> 

CLIMATIZACIÓN

CLIMATIZACIÓN · RACORES Y AISLANTES HISPACOLD

Racores reusables O-Ring.

Recto

G-16 T.G. 1" 5/16. Ref. 4300557
 G-12 T.G. 1" 1/16. Ref. 4300464
 G-12 T.G. 7/8". Ref. 4300467
 G-12 T.G. 1". Ref. 4300465
 G-10 T.G. 1". Ref. 4300458
 G-10 T.G. 3/4". Ref. 4300460
 G-10 T.G. 7/8". Ref. 4300462
 G-6 T.G. 5/8". Ref. 4300469



45°

G-16 T.G. 1" 5/16. Ref. 4300564
 G-12 T.G. 1". Ref. 4300376
 G-12 T.G. 1" 1/16. Ref. 4300378
 G-12 T.G. 7/8". Ref. 4300380
 G-10 T.G. 3/4". Ref. 4300372
 G-10 T.G. 7/8". Ref. 4300374
 G-10 T.G. 1". Ref. 4300369
 G-6 T.G. 5/8". Ref. 4300382



90°

G-16 T.G. 1" 5/16. Ref. 4300565
 G-12 T.G. 1". Ref. 4300422
 G-12 T.G. 7/8". Ref. 4300426
 G-12 T.G. 1" 1/16. Ref. 4300424
 G-10 T.G. 7/8". Ref. 4300421
 G-10 T.G. 3/4". Ref. 4300419
 G-10 T.G. 1". Ref. 4300417
 G-6 T.G. 5/8". Ref. 4300430



Racores Manuli.

Racores cónicos recto

DN22 T.G. 1" 1/16. Ref. 3400111
 DN16 T.G. 7/8". Ref. 3400114
 DN10.5 T.G. 3/4". Ref. 3400113
 Racores O-Ring recto
 DN22 T.G. 1" 1/16. Ref. 3400654
 DN16 T.G. 7/8". Ref. 3400657



Racores cónicos 45°

DN22 T.G. 1" 1/16. REF. 3400100
 DN16 T.G. 7/8". REF.- 3400102
 DN10.5 T.G. 3/4". REF.- 3400101
 Racores O-Ring 45°
 DN22 T.G. 1" 1/16. REF. 3400653
 DN16 T.G. 7/8". REF. 3400656



Racores cónicos 90°

DN22 T.G. 1" 1/16. Ref. 3400106
 DN16 T.G. 7/8". Ref. 3400109
 DN10.5 T.G. 3/4". Ref. 3400108
 Racores O-Ring 90°
 DN22 T.G. 1" 1/16. Ref. 3400652
 DN16 T.G. 7/8". Ref. 3400655



Racores reusables O-Ring.

Recto G-16 T.G. 1" 5/16. Ref. 4300693
 45° G-16 T.G. 1" 5/16. Ref. 4300691
 90° G-16 T.G. 1" 5/16. Ref. 4300692

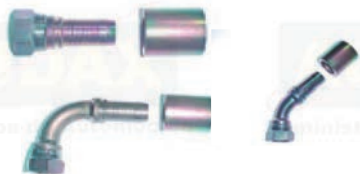

Aislante térmico para galerías y tapas de equipo.

Rollo 1x15 mt. 6 mm. Ref. XG0699EA
 Rollo 1x10 mt. 9 mm. Ref. XG0999EA
 Rollo 1x8 mt. 13 mm. Ref. XG1399EA
 Rollo 1x6 mt. 19 mm. Ref. XG1999EA
 Rollo 1x4 mt. 25 mm. Ref. XG2599EA
 Rollo 1x3 mt. 32 mm. Ref. XG3299EA
 Rollo 1x7 mt. 40 mm. Ref. XG4099EA

Autoadhesivo

Rollo 1x15 mt. 6 mm. Ref. XG0699E
 Rollo 1x10 mt. 9 mm. Ref. XG0999E
 Rollo 1x8 mt. 13 mm. Ref. XG1399E
 Rollo 1x6 mt. 19 mm. Ref. XG1999E
 Rollo 1x4 mt. 25 mm. Ref. XG2599E
 Rollo 1x3 mt. 32 mm. Ref. XG3299E
 Rollo 1x7 mt. 40 mm. Ref. XG4099E

Racores reusables O-Ring.

Recto 1" 1/8 T.G. 1" 5/16. Ref. 3400669
 90° 1" 1/8 T.G. 1" 5/16. Ref. 3400668



CLIMATIZACIÓN · PROGRAMADORES

Purificador ECO3.
Ref. 3350534



Ecomaster clima display.
Ref. 3200699



Ecomaster.
Nodo conductor. Ref. 3200701
Clima CPU. Ref. 3200698
Comfort nodo pasajeros. Ref. 3200702



Ecomaster Basic.
Ref. 3200835
Kit sustitución con adaptador.
Ref. 4150496



Mando programador temperatura.
Ref. 4CCCUWED



Mando programador soplado.
Ref. 88821165



Centralita roja.
Ref. 4CCCUWEC



Mando programador climatizador.
Ref. 4CCUWE2



CLIMATIZACIÓN · PROGRAMADORES

Mando programador climatizador
Iriconfort.
Ref. 3200687
Botonera. Ref. 3200646
Nodo
Iriconfort. Ref. 3200686
Nisplay Iriconfort. Ref. 3200635



Programador Ayats.
Ref. 08085013



Programador Carrier Süttrak.
Sustitución negro. Ref. 182198
Sustitución gris. Ref. 182200



Programador Beulas 2 zonas.
Ref. 7807600032



Kit mando programador Eberspacher.
Ref. 180106V2



Kit mando programador Eberspacher.
Ref. 00182200



Mando programador Airbus.
Ref. 12MANDO
Placa.
Ref. 12BASE



Mando programador frío calor Ako-Eliwell.
Ref. 14112



CLIMATIZACIÓN

CLIMATIZACIÓN · VARIOS

<p>Mando tensor aire 3 vías. Ref. 3100087</p> 	<p>Miniregulador presión MRBIT 1/8" 012. Ref. 3100126</p> 	<p>Válvulas antiretorno 1/8". Ref. 3100108</p> 
<p>Fuelle tensor SZ 35-11. Ref. 3270015</p> 	<p>Fuelle tensor SZ 11-5. Ref. 3270057</p> 	<p>Codo Racor 90° 1/8" 6 mm. Ref. 3400774</p>  <p>Racor recto 1/8" 6 mm. Ref. 3400804</p> 
<p>Presostato. Baja estanco. Ref. 4150181 Baja. Ref. 4150180</p> 	<p>Presostato. Alta estanco. Ref. 4150179 Alta. Ref. 4150178</p> 	<p>Sonda temperatura PTC-1000 verde. Ref. 4150267</p> 
<p>Sonda temperatura PT-100 negro. Ref. 4150188</p> 	<p>Sonda temperatura PT-1000 azul. Ref. 4150190</p> 	<p>Conjunto diodo. Ref. 4200366</p> 
<p>Conjunto diodo estanco. Ref. 4200367</p> 	<p>Filtro Setra. Ref. 20609005</p> 	<p>Motor para trampilla. Ref. 4230444</p> 

CLIMATIZACIÓN · EVAPORADORES Y CONDENSADORES PB

Nº	Descripción	Referencia
1	Batería de condensador derecha	3010353
2	Tubo válvula de servicio	4500416
3	Tubo G-12 TG G/10	3270091
4	Tapa registro	3270740
5	Batería de condensador izquierda	3010352
6	Rejilla cubremotor	3350216
7	Ventilador 11"	3270085
8	Motor de condensador	5300069
9	Soporte ventilador de condensador	3270082
10	Tapa de motor ventilador	4230376
11	Puente para unidad electrónica	4231292

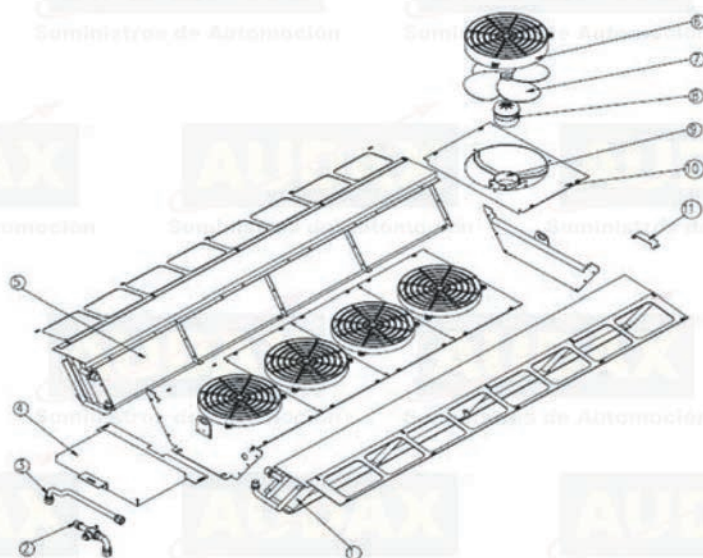

Nº	Descripción	Referencia
1	Placa fusibles	5010060
2	Nodo pasajeros Iricomfort	3200686
3	Presostato mini	3100094
4	Sensor aire PTC-1000 verde	4150267
5	Sensor humedad relativa	4150263
7	Te salida calefacción	4300800
8	Te entrada calefacción	4300799
9	Tubo G12 90-45 TG 7/8 L755 tub. flex.	4500282
10	Tubo líquido G10 90 G10 TG 180°	4500339
11	Compensador presión	3100100
12	Válvula expansión toex 4,5	3100099
13	Racor unión G12	4300476
14	Racor unión 5/8-5/8	4300485
15	Filtro DN 304	3100015
16	Tubo filtro-visor G-8	3270092
17	Visor depósito M-M 1/2	3100079
18	Tubo colector alta	3270090
19	Acoplamiento 1/8 MG-1/4 MS CRO	3400002
21	Tubo colector baja	3270089
24	Turbina doble s/esc	5300082
25	Batería evaporador + calefacción izquierda	3010361
25	Batería evaporador + calefacción derecha.	3010362
26	Tapa superior batería evaporador	4230840
27	Plataforma principal evaporador	3270736
28	Puerta evaporador aluminio	4231501
29	Kit motor trampilla	4230444

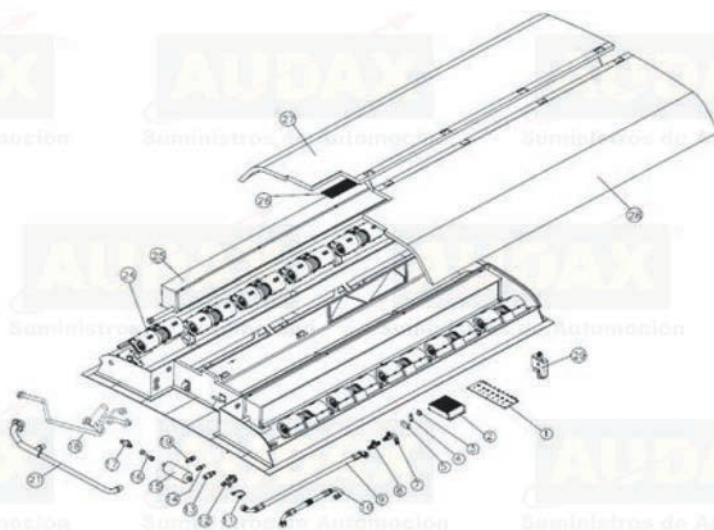

CLIMATIZACIÓN · TURBINAS HISPACOLD

Turbina doble universal Hispacold 24 V.
Ref. 5300068

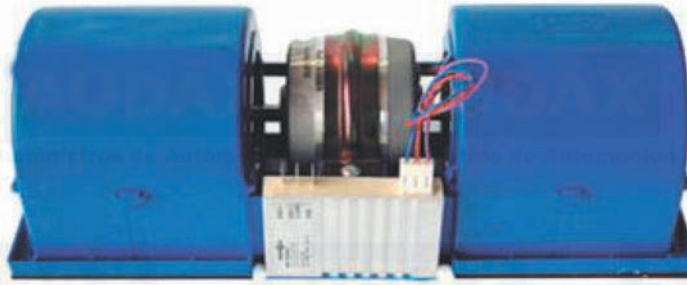

Aspas condensadora techo.
Aluminio D25. Ref. 3270800
Plástico PB D29. Ref. 4232250



Motor condensadora de 2 y 4 ventiladores Hispacold. Se despiezan aspas y soporte.
24V 9 espiras. Ref. 5300006
24V 8 espiras. Ref. 5300003
12V 8 espiras. Ref. 5300008



Turbina simple Century I.
Izquierda. Ref. 5300066
Derecha. Ref. 5300065



Rejilla condensadora techo.
4P Century. Ref. 3350122
3P PB. Ref. 3350216



Unidad electrónica PB.
Ref. 3200662



Unidad electrónica universal.
Ref. 3200627



Motor condensador techo Century.
Ref. 5300010



Motor condensador techo Andecar, Irizar
Century antiguo Iveco e Irisbus Integrados.
24 V. Ref. 5300077
24 V. Ref. 5300018
12 V. Ref. 5300005



Motor condensador PB.
Ref. 3050071



CLIMATIZACIÓN · TURBINAS SPAL

Turbina.
Ayats Atlas, Airbus, Hispacold y otros. 24 V. Ref. 005B4602
Airbus. 12 V. Ref. 005A4602



Turbina 24 V.
Ref. 006B50VLIET22
Mercedes, Setra y Webasto. Ref. WEBASTO009B40IET22



Turbina Carrier.
Ref. 009B3922
Ref. 009B4022

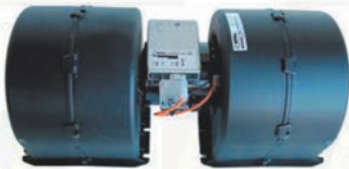

Turbina.
24 V. Thermoking. Ref. 006B4622
24 V. Hispacold. Ref. 006B4022
24 V. Carrier y PB. Ref. 006B5022



Turbina doble universal Spal para Hispacold, Carrier.
Ref. 008B4602

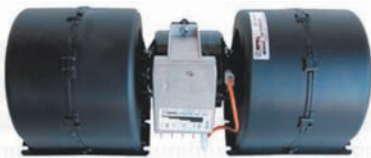

Turbina Ayats pequeña.
Ref. 009B7074D008B37C42D



Ventiladores.
Diavia. Ref. VA07BP7C31A/S
Unvi Airbus. Ref. VA09AP8C54A/S
Ref. VA11AP8C29A/S
Airbus. Ref. VA14AP7C34A/S



Ventiladores.
Ayats, Noge y otros. Ref. VA01BP70LL36A/S
Setra Airbus, Carrier. Ref. VA03BP70LL37A/S
Setra S3/S4. Ref. VA03BP70LL37SF



CLIMATIZACIÓN · TURBINAS Y FILTROS

Turbina equipo Carrier.
Ref. 140034



Turbina.
Equipo Carrier. Ref. 7137200027
Sin electrónica. Ref. 7137200021



Turbina para equipo Carrier.
Ref. 7137200043



Turbina individual.
Ref. 7137200055
Antivaho. Ref. 8141320226
Con resistencia. Ref. 8141320228



Filtro aire climatizador blanco.
8 mm. Ref. K8
15 mm. Ref. K15



Filtro aire climatizador espuma.
10 mm. 1x2 mts. Ref. PPI2010
20 mm. 1x2 mts. Ref. PPI2020



Filtro aire climatizador Irizar PB y
Century.
Ref. 592793



Filtro aire climatizador universal UCC NC.
Ref. 4231519



CLIMATIZACIÓN · GRIFOS Y BOMBAS

Grifo calefacción eléctrico.
Ref. 4231368
Motor sustitución. Ref. 4231534



Grifo calefacción eléctrico.
Ref. 4231620
Motor sustitución. Ref. 4231534



Grifo calefacción eléctrico.
Ref. 7147400299



Bomba precalentador Spheros 6.000 litros.
Ref. U4856



Bomba precalentador Webasto, Spheros
y Eberspächer.
Ref. 43152D



Bomba calefacción CM30P7.
Ref. CBW10477



CLIMATIZACIÓN · CONVECTORES

Válvula calefacción neumática.
Normal abierta. Ref. 438257
Normal cerrada. Ref. 438259



Válvula calefacción eléctrica.
1/2" 24 V. Ref. 8414
3/4" 24 V. Ref. 8415
1" 24 V. Ref. 8416



Conveectores de calefacción para autobuses y autocares. Fabricación a medida bajo proyecto. Largos entre 0,5 a 5 metros.

Construcción completa en aluminio.
L1
150 cm. 1.400 kcal. Ref. 81500016
170 cm. 1.500 kcal. Ref. 81500014
200 cm. 1.800 kcal. Ref. 81500010
235 cm. 2.000 kcal. Ref. 81500012

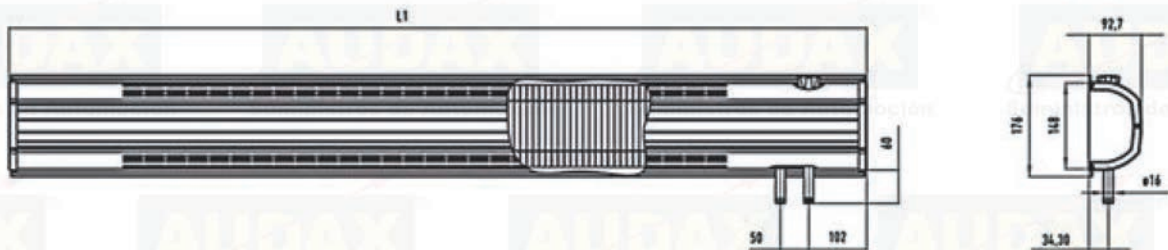

Conveectores de calefacción para autobuses y autocares. Construcción completa en aluminio curvado de alto rendimiento.

L1 200 cm.
1.350 kcal. Ref. 81500060
2.500 kcal 40 m3 caudal de aire. Ref. 81500041

